

All stainless steel bimetal thermometer

Model E

Nominal size 5"

Accuracy: Grade A (1 %) according to ASME B40.200



Features

- Rugged all welded stainless steel construction
- Hermetically sealed case to prevent entry of moisture, interior corrosion and coil freeze-up
- Protection IP66
- Optional ATEX approved **CE** II 2 GD c Tx°C IP66
- Maxivision® dial allows readability from any angle without parallax error
- External adjustment permits zero reset from outside the case.
- Dry or liquid filled
- Silicone coil dampening provides vibration dampening and improves response time

Ranges

-50 ... 50 °C up to 0 ... 500 °C

-80 ... 120 °F up to 200 ... 1000 °F

Applications

- Chemical and petrochemical industry
- Machine and apparatus construction
- Food and beverage industry
- Pulp and paper industry

Technical specification	EM, EE, EI, E3B
Dial size	5" (125 mm)
Construction	Cylindrical case with crimp ring, hermetically sealed and external adjustment
Measuring principle	Bimetallic coil
Range in °C	0/50 0/60 0/80 0/100 0/120 0/150 0/160 0/200 0/250 0/300 0/400 0/500 10/150 50/300 50/450 100/500 -10/50 -10/110 -20/40 -20/60 -20/120 -20/180 -25/25 -30/50 -30/70 -40/40 -40/60 -40/160 -50/50
Ranges in °F	0/100 0/150 0/200 0/250 0/300 0/350 0/500 20/120 30/130 30/240 50/300 50/400 50/550 80/180 100/800 160/360 170/270 200/400 200/700 200/1000 -40/120 -40/160 -20/120 -80/120 -10/100
Temperature limits for ranges	< 120 °C ≥ 120 °C and < 290 °C ≥ 290 °C
Max. process overtemperature	100 % of span 50 % of span max. 425 °C for continuous service
Max. ambient temperature	94 °C with dry case, 65 °C with liquid filling
Stem	
Diameter	6 mm, 8 mm, 1/4" (6,4 mm), 3/8" (9,6 mm)
Length	63 ... 1000 mm, minimum length depends on range
Process connection	Plain G 1/2 A male, G 1/2 female, 1/2 NPT male or 1/2 NPT female G 3/4 A male, G 3/4 female, 3/4 NPT male or 3/4 NPT female G 1 A male, G 1 female, 1 NPT male or 1 NPT female, others on request Fixed, adjustable or with swivel nut
Connection location	Back, lower and every angle (rotatable)
Material	
Connection	Stainless steel 316L or 316Ti (1.4404 or 1.4571)
Stem	Stainless steel 316L or 316Ti (1.4404 or 1.4571)
Case/ring	Stainless steel 304 (1.4301), optional 316L (1.4404) for most case styles
Window	Instrument glass, optional shatter proof glass or acrylic glass
Dial	Aluminum, black markings on white background, anti parallax Maxivision® dial
Pointer	Aluminum, black
Accuracy	Grade A (1 %) according to ASME B40.200 (former ASME B40.3)
Protection according EN 60 529/IEC 529	IP66
Conformity according to RL 94/9/EC appendix X for mechanical equipment in potential hazardous areas	Optional, Marking CE II 2 GD c Tx°C IP66 File no. 35088073 at notified body 0044, TUV NORD CERT (only with shatter proof glass)
Filling liquids	Silicone, not for lower connection, not for ATEX, acrylic glass is standard, Maximum range up to 300 °C
Weight in kg	
Connection location	Back Lower Every angle
Dry	0,4 0,6 0,6
Filled	0,7 -- 0,9
Accessories	Thermowells must be used on all pressure or velocity applications, to protect the stem of thermometer from corrosion and physical damage, and to facilitate removal of the thermometer without disturbing the process.

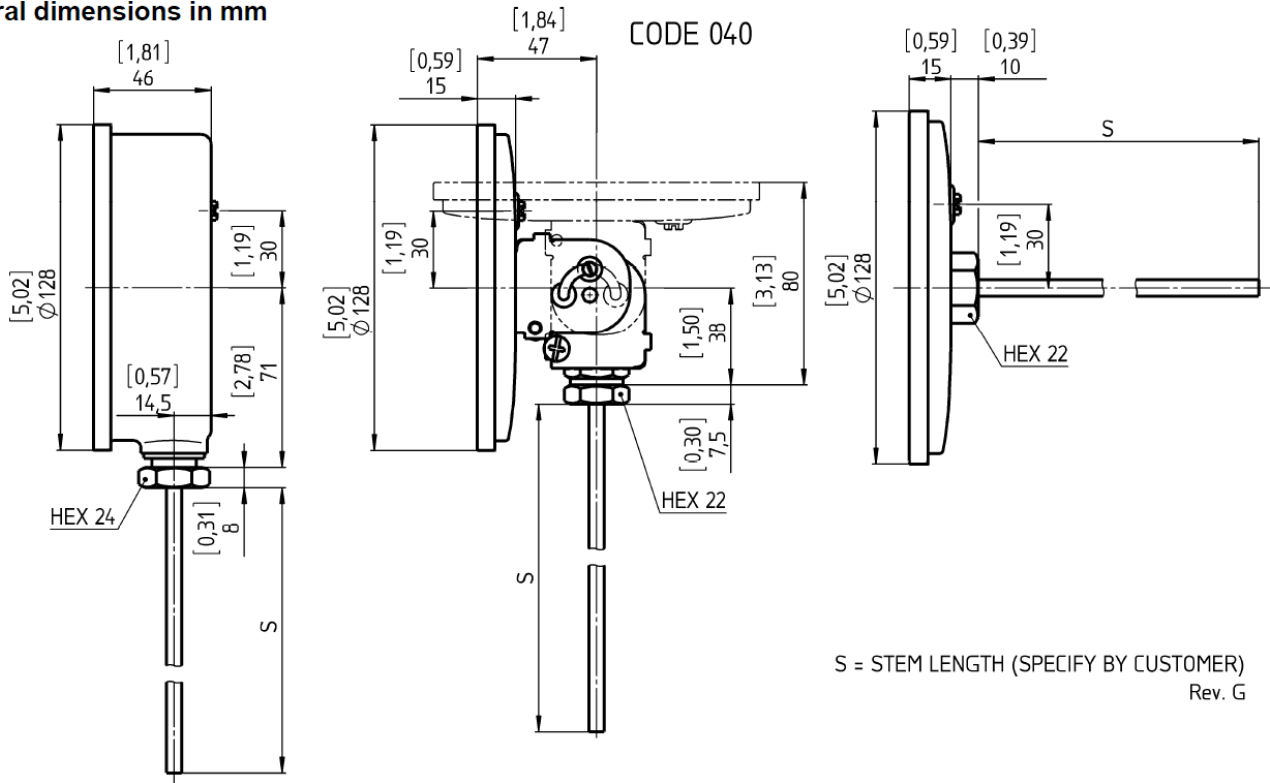

Order information

Size	Type and stem execution	Filling	Process connection	Connection orientation	Stem length	Range	Options	
(50) 5" (125 mm)	(EM) 6 mm	(=) Standard (no filling)	(040) Plain	(L) Lower	63 to 1000 mm	0/ 50 °C ¹⁾	(NH) Stainless steel tag wired	
	(EE) 8 mm	(L) Liquid filled with silicone max. range 300 °C (not for lower connection, ambient temperature maximum 65 °C)	(042) Union outlet ½ NPT male	(R) Back		0/ 60 °C ¹⁾	(CS) Dual scale	
	(EI) ¼" (6,4 mm)		(060) Fixed ½ NPT male	(E) Every angle		0/ 80 °C ¹⁾	(DA) Dial marking	
	(E3B) 3/8" (9,6 mm)		(061) Fixed G ½ A male	(061) Fixed G ½ A male		(070) Adjustable union ½ NPT male	0/100 °C ¹⁾	(PD) Acrylic glass
			(071) Adjustable union G ½ A male	(071) Adjustable union G ½ A male		(072) Adjustable union ¾ NPT male	0/120 °C ¹⁾	(SG) Shatter proof glass
			(072) Adjustable union ¾ NPT male	(072) Adjustable union ¾ NPT male		(074) Adjustable union ½ NPT female	0/150 °C ¹⁾	(YW) 316L (1.4404) housing
			(074) Adjustable union ½ NPT female	(074) Adjustable union ½ NPT female		(080) Swivel nut G ½ A male	0/160 °C ¹⁾	(C4) Individual calibration certificate
			(080) Swivel nut G ½ A male	(080) Swivel nut G ½ A male		(081) Swivel nut G ½ female	0/180 °C ¹⁾	(ATEX) ATEX approval
			(081) Swivel nut G ½ female	(081) Swivel nut G ½ female		Other process connections are available on request.	0/200 °C ¹⁾	
							0/250 °C ¹⁾	
							0/300 °C ¹⁾	
							0/400 °C ¹⁾	
							0/500 °C ¹⁾	
				10/150 °C				
			50/300 °C ¹⁾					
			50/450 °C ¹⁾					
			100/500 °C ¹⁾					
			-10/ 50 °C ¹⁾					
			-10/110 °C					
			-20/ 40 °C ¹⁾					
			-20/ 60 °C ¹⁾					
			-20/180 °C					
			-25/ 25 °C ¹⁾					
			-30/ 50 °C ¹⁾					
			-30/ 70 °C					
			-30/170 °C					
			-40/ 40 °C ¹⁾					
			-40/ 60 °C					
			-40/100 °C					
			-40/160 °C					
			-50/ 50 °C					

Order example

Size	Type and stem execution	Filling	Process connection	Connection orientation	Stem length	Range	Engineering unit	Options
50	EI	=	070	E	150	0/200	C	NH

Detailed specification and general dimensions of process connection

Union outlet code 042

Length S is fixed, but orientation can be adjusted with union connection.
Code 042 1/2 NPT male

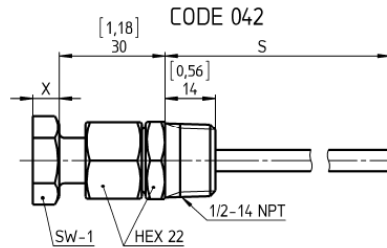

CODE 042	SW-1	X
L	24	8 [0,31]
E	22	9,8 [0,39]
R	22	7,5 [0,30]

Fixed connection code 060 and 061

Length S is fixed.
Code 060 1/2 NPT male
Code 061 G 1/2 A male

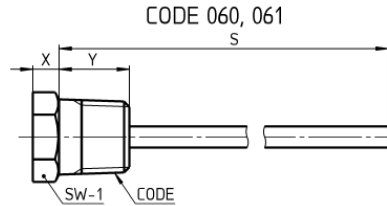

CODE 060 1/2-14 NPT	SW-1	X	Y
L	24	8 [0,31]	20 [0,79]
E	22	9,8 [0,39]	20 [0,79]
R	22	7,5 [0,30]	20 [0,79]
CODE 061 G 1/2 A L/E/R	27	12 [0,47]	12 [0,47]

Adjustable union connection code 070, 071 and 072

Length S and orientation can be adjusted with union connection.
Code 070 1/2 NPT male
Code 071 G 1/2 A male
Code 072 3/4 NPT male

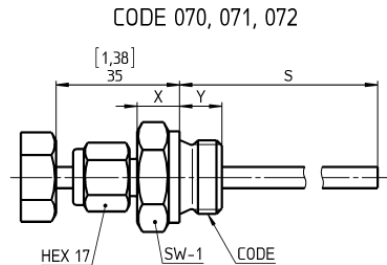

L/E/R	SW-1	X	Y
CODE 070 1/2-14 NPT	22	7,5 [0,30]	20 [0,79]
CODE 071 G 1/2 A	27	12 [0,47]	12 [0,47]
CODE 072 3/4-14 NPT	27	9 [0,35]	20 [0,79]

Adjustable union connection code 074

Length S and orientation can be adjusted with union connection.
Code 074 1/2 NPT female

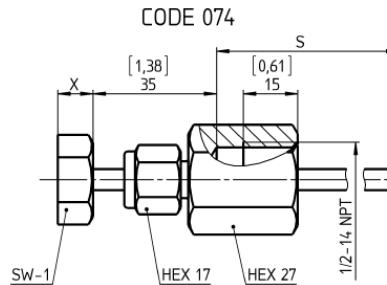

CODE 074	SW-1	X
L	24	8 [0,31]
E	22	7,5 [0,30]
R	22	10 [0,39]

Swivel nut connection code 080

Length S is fixed, but orientation can be adjusted with swivel nut.
Code 080 G 1/2 A male

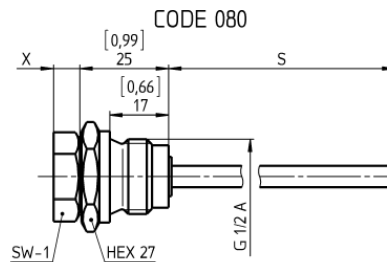

CODE 080	SW-1	X
L	24	8 [0,31]
E	22	7,5 [0,30]
R	22	7,5 [0,30]

Swivel nut connection code 081

Length S is fixed, but orientation can be adjusted with swivel nut.
Code 081 G 1/2 female

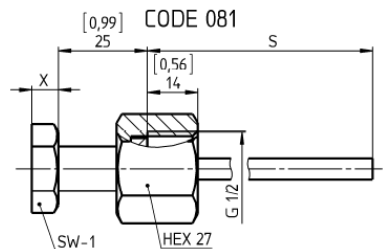

CODE 081	SW-1	X
L	24	8 [0,31]
E	22	7,5 [0,30]
R	22	7,5 [0,30]