



## Cast Iron Dual Plate Wafer Check Valve

### Features

- Universal Flange Mounting PN10 PN16 ASA150
- Epoxy Coat Finish

### Pressure/Temperature

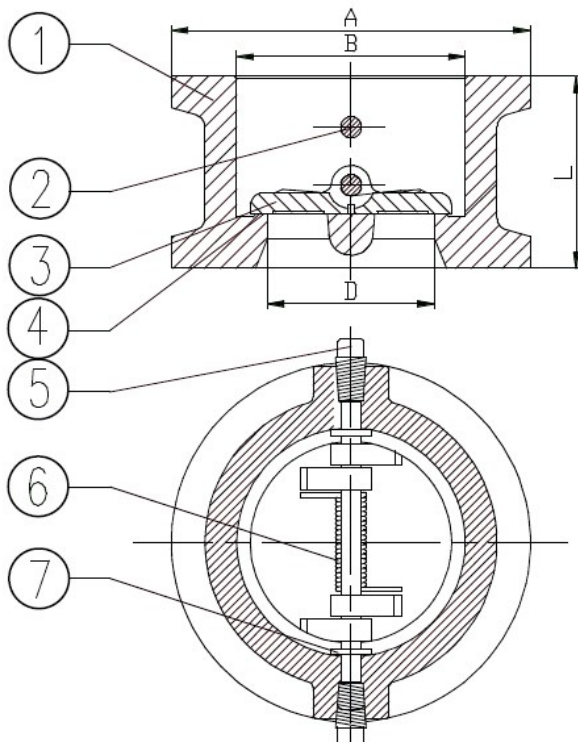
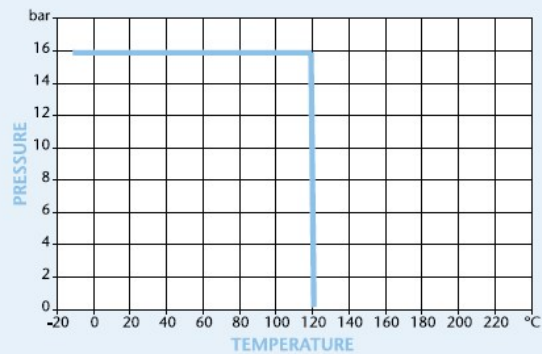

DN	50	65	80	100	125	150	200	250	300
A	109	129	144	164	125	150	275	330	386
B	65	80	94	117	145	170	224	265	310
D	43	57	70	88	115	134	182	220	260
L	43	46	64	64	70	76	89	114	114
Kgs	1.5	2.4	3.6	5.7	7.3	9	17	26	42

### Technical Data

Maximum Pressure 16 Bar

Working Temperature -10°C to +120°C

N.	Part Name	Materials
1	Body	Cast Iron GG25
2	Shaft	Stainless Steel 316
3	Disc	Stainless Steel 316
4	Seat	EPDM
5	Plug	Stainless Steel
6	Spring	Stainless Steel 316
7	Washer	Stainlee Steel or PTFE

Dimensions in mm

This data sheet is designed as a guide and should not be regarded as wholly accurate in every detail. We reserve the right to amend the specification of any product without notice.