



PN16 Stainless Steel Globe Valve

Features

- Screwed BSP Parallel
- PTFE Seals
- Metal Seat
- PN16 Rated

Pressure / Temperature

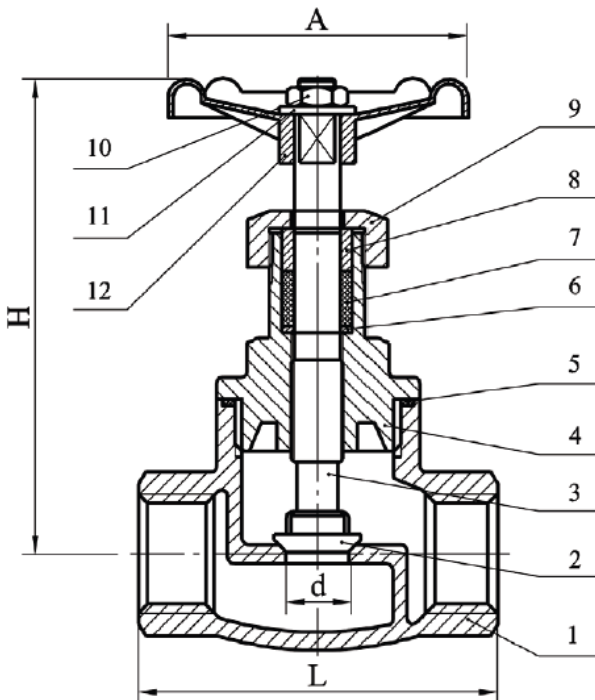
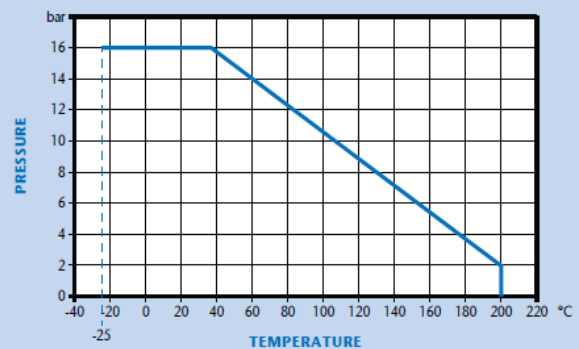

DN	1/4"	3/8"	1/2"	3/4"	1"	1 1/4"	1 1/2"	2"
d	10	12	15	20	25	32	40	50
L	67	67	67	80	89	100	118	134
H	79	79	79	91	106	125	136	146
A	66	66	66	71	77	90	105	105
Kgs	0.42	0.42	0.40	0.57	0.80	1.30	1.84	2.40

Technical Data

Max Pressure	16 Bar
Working Temperature	-25°C to +200°C

N.	Part Name	Material
1	Body	CF8M
2	Petal	Stainless Steel 316
3	Stem	Stainless Steel 316
4	Cap	CF8M
5	Gasket	PTFE
6	Washer	Stainless Steel 304
7	Stem Packing	PTFE
8	Ring	Stainless Steel 304
9	Gland Ring	Stainless Steel 304
10	Wheel Nut	Stainless Steel 304
11	Plate	Stainless Steel 304
12	Hand Wheel	Aluminium Alloy

Dimensions in mm

This data sheet is designed as a guide and should not be regarded as wholly accurate in every detail. We reserve the right to amend the specification of any product without notice.